

ATLANTIS

1700 Freestanding Bath

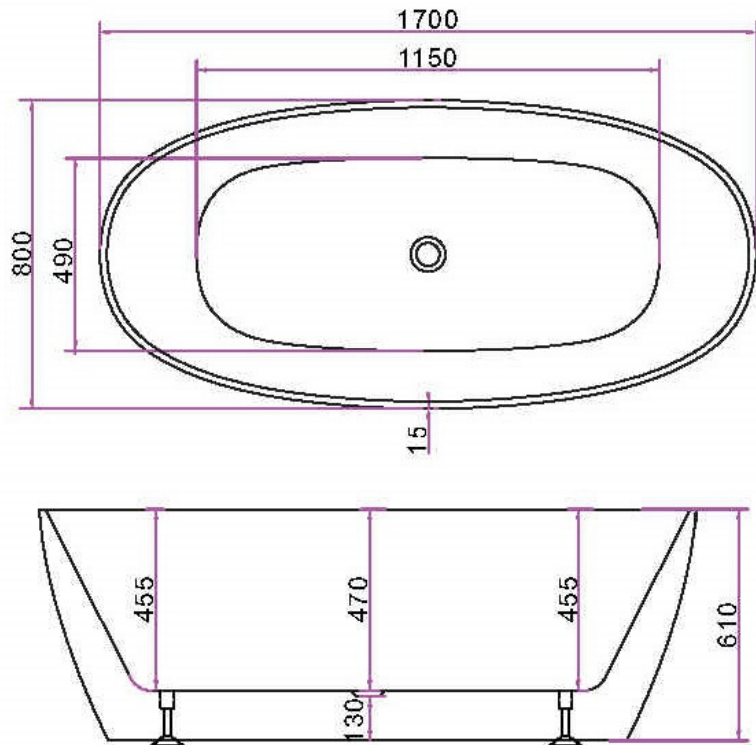

- Freestanding Bath
- Super thin 15mm edge design
- Sanitary Grade Acrylic
- Adjustable feet for easy installation
- Centre Waste
- 1700 x 800 x 610

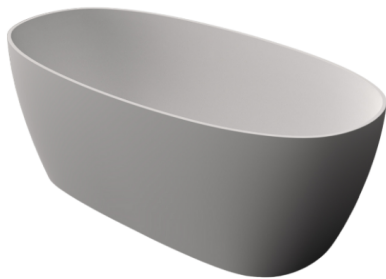

SKU: 1646950

swan | bathrooms

swanbathrooms.com.au | 1800 571 060

- Disclaimer:** Dimensions are nominal measurements only and are subject to change without notice. Always use physical products for setouts and roughing in, as specification drawings can vary from actual product received.
- ALLOW +/- VARIATIONS TO THESE MEASUREMENTS.
 - FOR FLUSH FINISH TO WALL - WALLS MUST BE STRAIGHT BEFORE INSTALLATION.
 - WHERE BATH CONNECTS TO A WALL, IT MAY HAVE A 10MM VARIATION THAT WILL REQUIRE CAULKING.

Warranty: Conditions apply - full terms and conditions available upon request

V: 10/21